

Veraviewepocs 3D

F40 and R100 with innovative 3D Reuleaux FOV



Thinking ahead. Focused on life.

Veraviewepocs 3D R100

A New Frontier in X-ray Diagnostics

Veraviewepocs 3D R100 has changed the shape of 3D. This unit's groundbreaking and patent pending 3D Reuleaux Full Arch fields of view (FOVs) provide a unique shape for full arch imaging. With 6 field of view options and Morita's world renowned image quality, Veraviewepocs 3D R100 is suitable for a wide variety of dental applications including implant planning.



3D Reuleaux Full Arch FOV



3D Reuleaux Full Arch Field of View

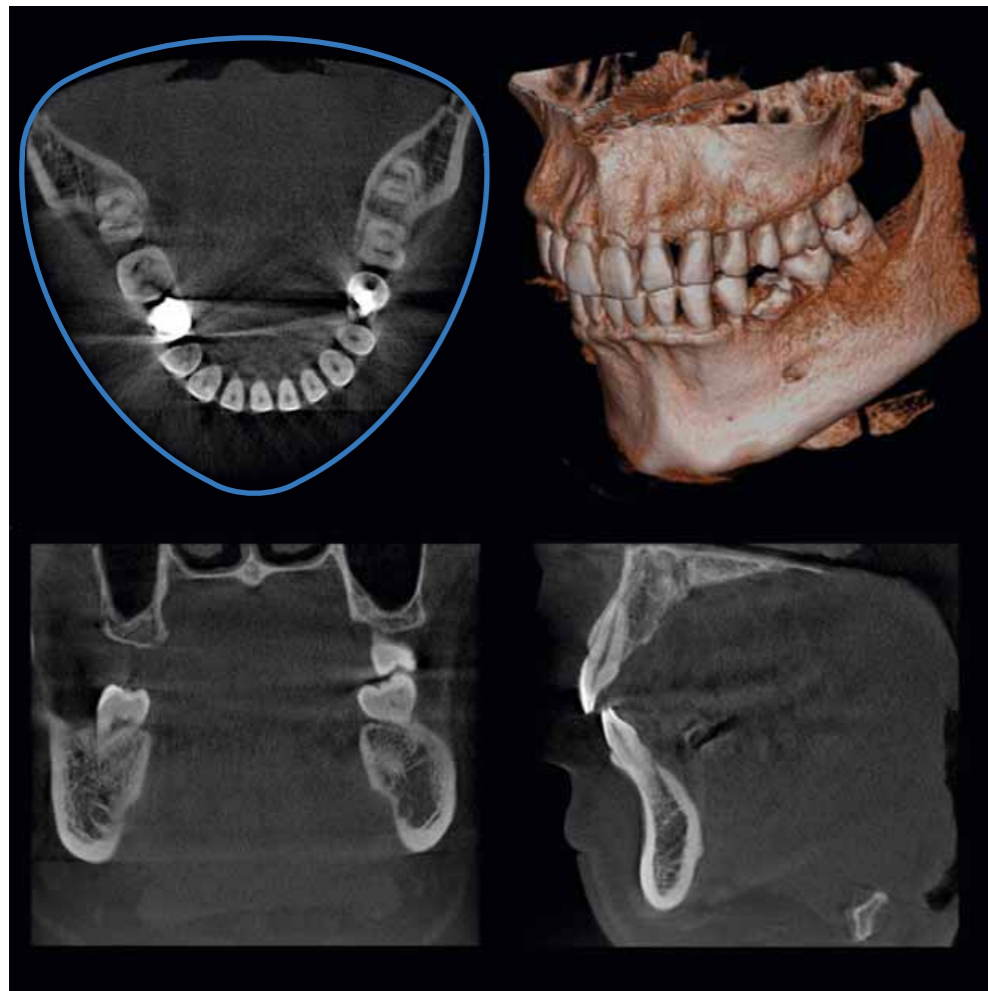

Blue line indicates new full arch FOV, equivalent to $\varnothing 100$ mm.

New Patent Pending Technology

Morita's new and completely unique 3D Reuleaux Full Arch FOV abandons the typical cylinder with a new convex triangle shape. By more closely matching the natural dental

arch form, this groundbreaking FOV reduces dosage by excluding areas outside the region of interest and allows a complete scan of the maxilla and/or the mandible.

Innovative 3D Reuleaux Full Arch FOV reduces dosage.

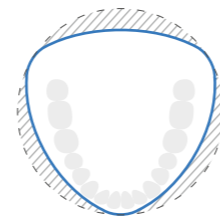

Not available on the Veraviewepocs 3D F40 model.

Various Fields of View

Exposure Areas for Multiple Diagnostics

The Veraviewepocs 3D R100 model offers a total of 6 exposure areas from 40 x 40 mm up to 100 x 80 mm for various diagnostic needs.

The new full arch scan captures the maxilla and/or the mandible with the equivalent of 100 mm in diameter and two height options of 50 or 80 mm. Its full arch capability, reduced dosage and exceptional clarity are ideal features for implant planning and oral surgery. This unit also offers small and medium field of view sizes suitable for endodontics, periodontics, as well as general dentistry.

The Veraviewepocs 3D F40 model offers 40 x 80 mm and 40 x 40 mm fields of view, also suitable for a variety of applications.

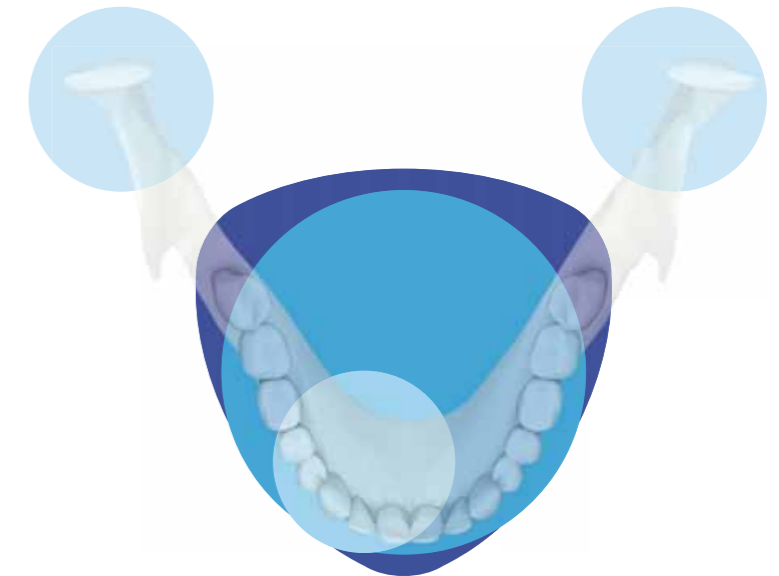

R100 Full Arch FOV

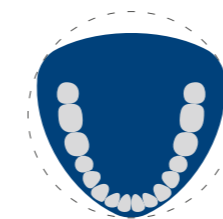

$\varnothing 80$ FOV

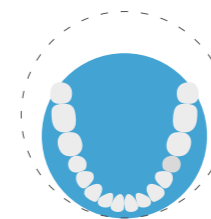

$\varnothing 40$ FOV

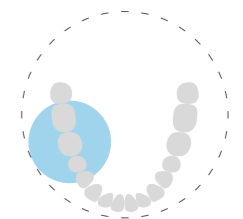

$\varnothing 100$ mm

Fields of View



$\varnothing 100 \times H 80$ mm*



$\varnothing 100 \times H 50$ mm*



$\varnothing 80 \times H 80$ mm



$\varnothing 80 \times H 50$ mm



$\varnothing 40 \times H 80$ mm



$\varnothing 40 \times H 40$ mm

Veraviewepocs 3D R100 only

Veraviewepocs 3D R100 and Veraviewepocs 3D F40

*3D Reuleaux Full Arch FOV

High Resolution Images

With Dose Reduction Feature

Dose Reduction Feature

Through advanced engineering, a Dose Reduction Mode optimizes the intensity of the X-rays which lowers exposure for easily penetrated tissues. Dosage is reduced to a mere 40 % of the standard mode.* By maximizing efficiency, soft tissue, such as the maxillary sinus membrane and skin, appear sharper than ever before with fewer artifacts.**



40 x 80 mm high resolution image taken in Dose Reduction Mode

Resolution & Clarity

Veraviewepocs offers high resolution images of 125 μ m voxel. It provides clear images of the periodontal pocket, the periodontal ligament, and the alveolar bone. It is extremely useful for implant therapy from planning to post-operative observation.

Spatial Resolution MTF: Modulation Transfer Function

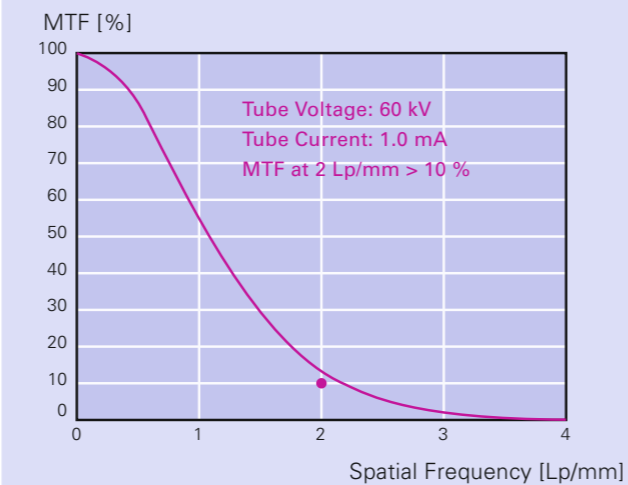

Super-High Resolution for All Image Areas

The resolution of Veraviewepocs is greater than 2 line pairs per mm (MTF 10%). The highly detailed images have a voxel size of 0.125 mm per side, and the slice thickness and interval can be set between 0.125 and 12.375 mm. The expanded radiographic area of \varnothing 80 x H 80 mm maintains the same high resolution as the smaller fields of view.

* For 40 X 80 mm exposures. ** Compared to standard exposure mode.

Easy 3D Positioning

Flexibility

Veraviewepocs offers flexibility in positioning methods. The region of interest can be positioned by the panoramic image, the bi-directional scout, or the 5 positioning laser beams.

Panoramic Image with Scout Feature

Before taking a 3D image, a high resolution panoramic exposure is taken to target the region of interest on the PC monitor. The C-arm will automatically move into the optimum patient position to get 3D images at the center of the region of interest.

Bi-directional Scout

After initial positioning is accomplished by the 3 positioning laser beams, bi-directional X-ray images can be taken to confirm that the position is accurate. If it is not, simply adjust the position of the image on the computer by placing the cursor at the center of the region of interest.

Direct Positioning with 5 Laser Beams

5 positioning laser beams set the patient's position and align the region of interest. First, the patient's initial position is set using the 3 laser beams. Then, 2 additional laser beams are aligned to the region of interest. The C-arm will automatically move to the right position.

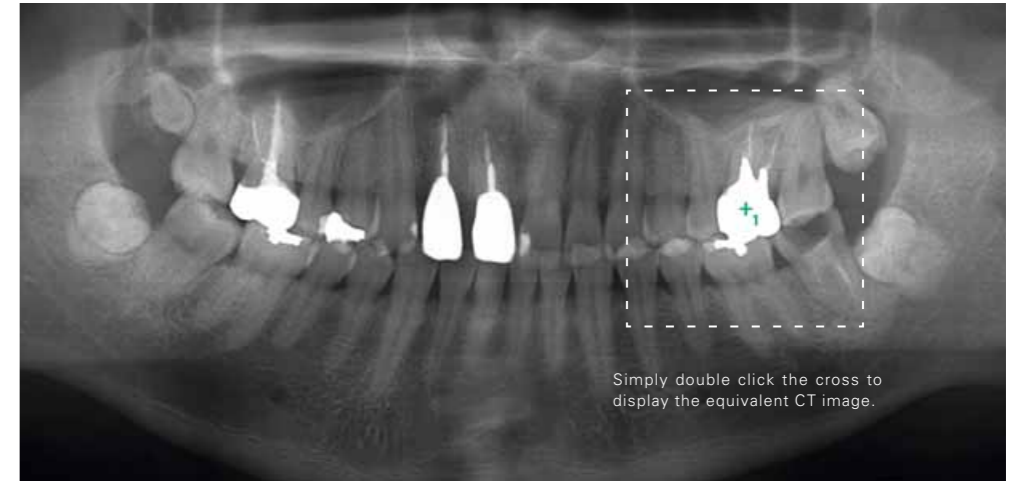

Clinical Case Example

The panoramic image above suggests that there is an apical lesion on the distal root of tooth #26. Further inspection with a 3D image, however, shows that the lesion is on the buccal side of an extremely curved mesial root.

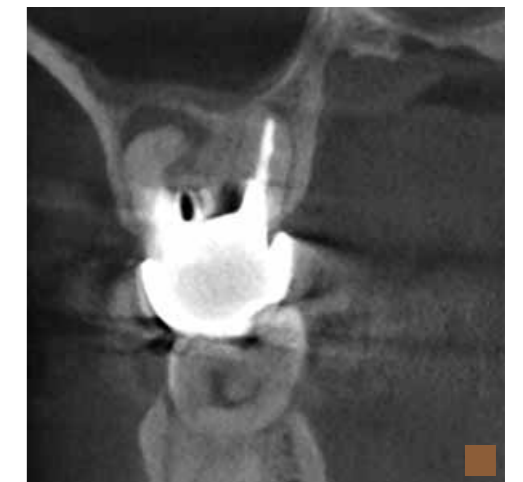
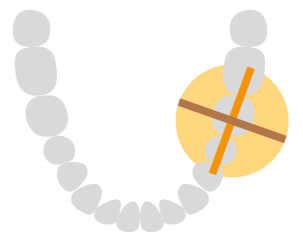

3D Images for Implant Planning

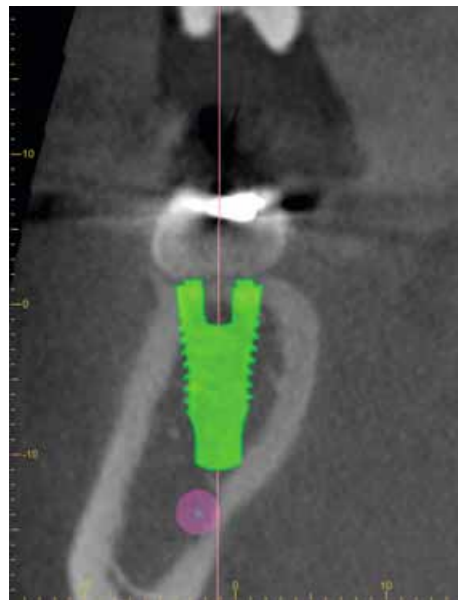
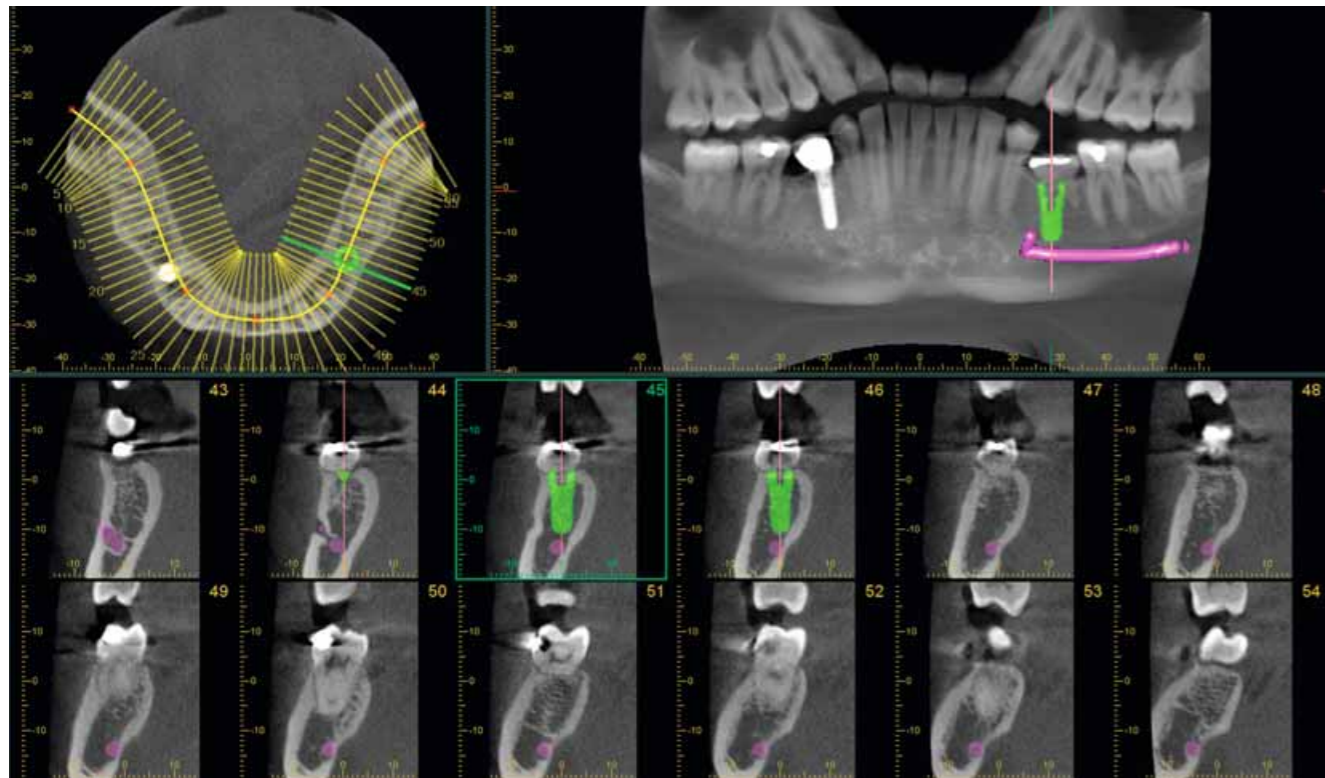

Planning Process

Successful placement of implants starts with the very critical and detailed planning process. Identification of structures such as the sinus cavity, inferior alveolar nerve and clear views of the bone structure are needed.

Veriviewepocs 3D R100 is ideal for implant planning with full arch imaging, industry leading clarity, and low dosage to the patient.

Software

i-Dixel 2.0 software offers advanced implant planning features, plus compatibility with popular third party software.

cMPR Image Processing

Create cross sectional images of the dental arch.

Mandibular Canal Tracing

Highlight the mandibular canal for easier viewing, measuring the distance to the implant and determining its buccal and lingual position.

Advanced Software Features

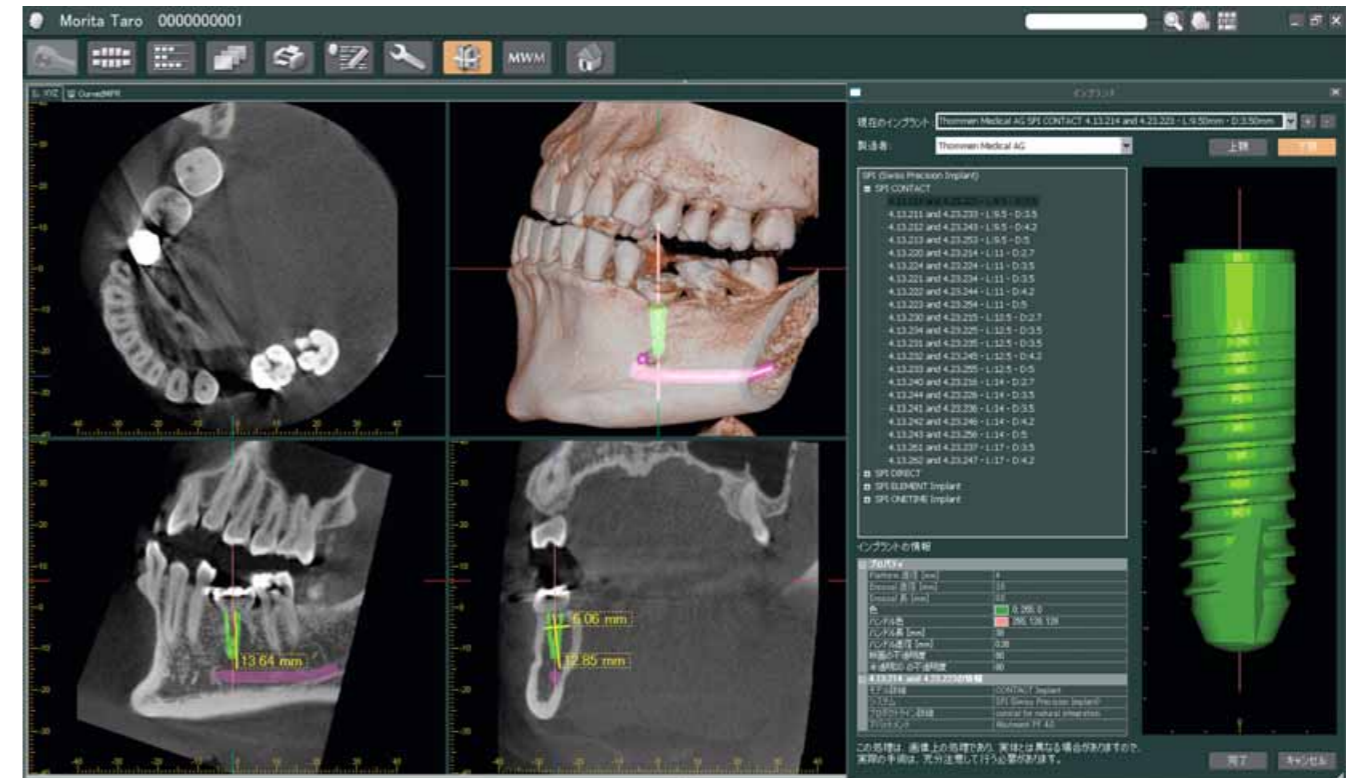

Confirm Implant Position with Volume Rendered Image

A high resolution volume rendered image of the entire jaw can be created. This rendering makes it easy to explain each step of the implant planning and treatment process to the patient.

Implant Library

The implant library can be used to make realistic presentations for patients.

Link to Implant Simulation Software

By converting images to DICOM formats, implant simulation can be performed with other third party software.

Presentation Preparation

The data for implant devices including length and diameter can be used to superimpose an image of the device on a 3D image to show patients and others.



Clinical Cases

Implantology

The patient was seen for a routine follow up visit following implant placement of tooth #16. The implant had been placed 9 years earlier. The coronal, sagittal, and axial views all confirm good quality bone around the implant and an absence of any pathology related to the treatment. The fine detail of the bone, especially in the coronal view, allows the clinician and the patient to feel confident about the current health of the implant.



Endodontics

The patient presented with a radiolucency around tooth #26 that had previously been treated endodontically. Conventional 2D imaging was inconclusive so a cone beam CT image was taken with the 3D R100. The sagittal and coronal views both showed that the endodontic therapy was failing and there were apical lesions on both the buccal and palatal roots.

The sagittal view clearly confirms a perforation of the Schneiderian membrane, while the coronal view identifies odontogenic maxillary sinusitis and mucosal thickening. The damage to the sinus membrane may have been overlooked if this case was diagnosed and treatment planned with an image that did not show the problem so clearly.

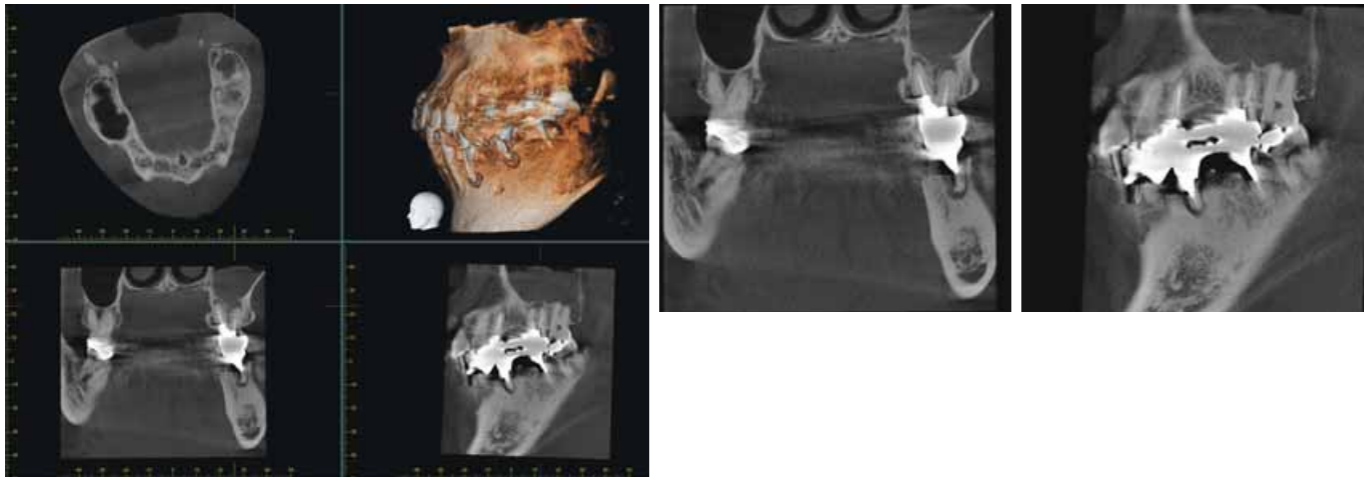

Oral Surgery

The patient presented with pain in the maxillary left region. A cone beam CT image was taken with the 3D R100 and it was revealed that tooth #28 was in fact impacted and was causing problems for tooth #27. The axial view demonstrated extensive bone loss near the apical area of #27 due to the lack of arch space needed for #28 to erupt.

The coronal view showed bone destruction all the way through the furcation of #27. The sagittal image not only shows the loss of osseous support around the entire apex of #27, but also shows damage to the sinus floor and mucosal thickening.

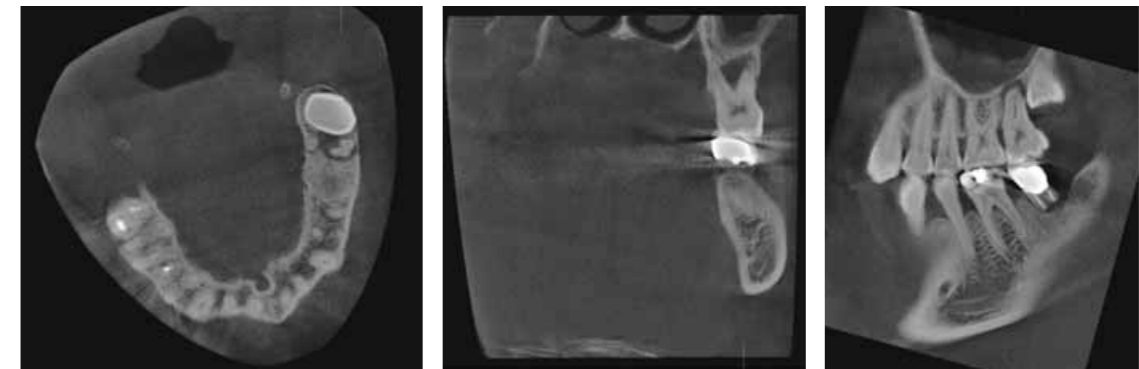
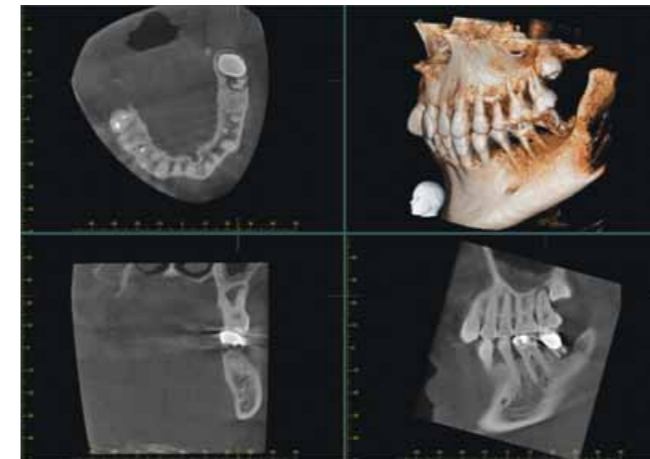

A portion of the clinical images were provided by Kitanenju Radist Dental Clinic, i-View Imaging Center, Japan.

Panoramic Imaging



After Image Layer Adjustment

AF Automatic Positioning

This function makes patient positioning nearly effortless. A light beam sensor automatically positions the unit without requiring the patient to move. The light beam sensor measures the distance to the patient's teeth, then the arm automatically moves into the optimal position. This process produces images with a high degree of reproducibility.

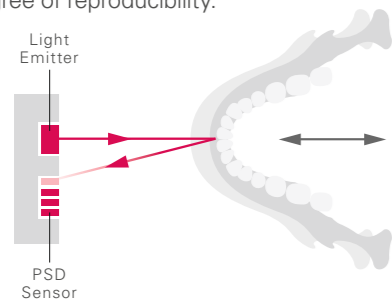

AF Automatic positioning Technology

DDAE (Digital Direct Auto Exposure)

The DDAE function controls X-ray emission in real time depending on the area being examined and produces a wide dynamic range, as well as sharp and exceptionally clear images.

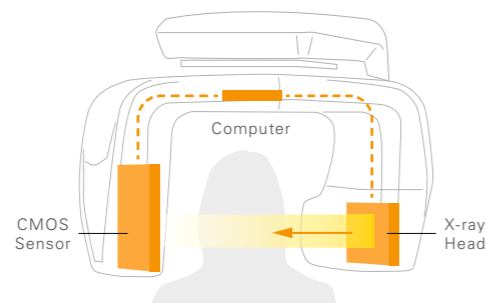

DDAE Mechanism

AIE (Auto Image Enhancement)

This software processing function uses a logarithmic conversion to adjust the overall density and to highlight shaded details, creating a better image.

Standard Panoramic

The X-Y movement and arm rotation are coordinated by a computer control system to create a projection with the optimum image layer shape.

Orthogonal Panoramic

This projection controls the angle of X-ray penetration to reduce the overlapping of individual teeth.

Shadow Reduction Panoramic

This projection controls the angle of X-ray penetration to reduce the mandibular ramus shadow.

Image Layer Adjustment After Exposure

Panoramic Image Layer Adjustment

The image layer for panoramic images can be adjusted after the exposure has been made to improve clarity and sharpness. The focus can be improved for points of varying depth as well as the surface. Select any point in the image for focus enhancement and then use the mouse wheel to make the adjustment.

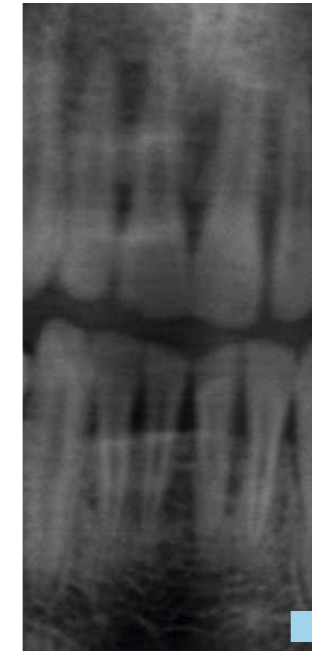

Before Image Layer Adjustment

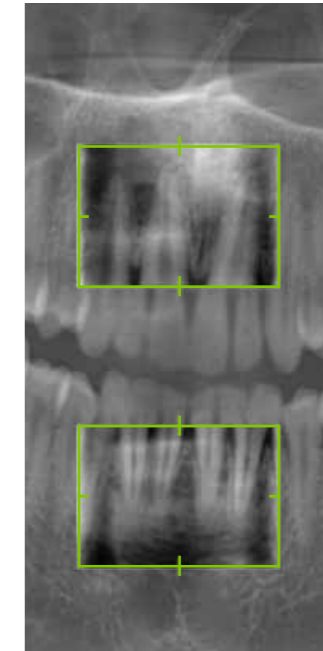

Preview images are shown in the green frame to support the manipulation of image layer adjustment



After Image Layer Adjustment

Image Layer Adjustment Options

With various methods, the image layer can be adjusted to obtain optimum image results.

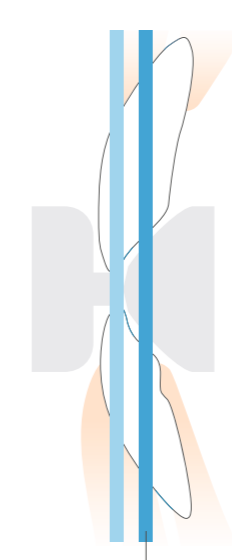

Adjusted Image Layer
Single point adjustment – simply adjust the image layer alignment to the posterior and anterior direction.

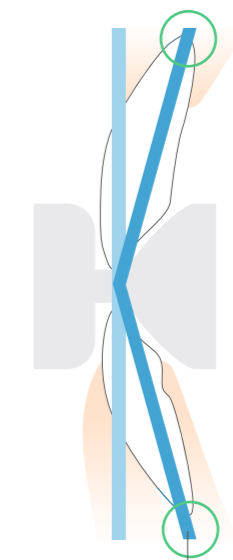

Adjusted Image Layer
Two points adjustment – the image layer position of the apical region can be adjusted separately at the mandibular and the maxilla. The layer position at the occlusal plane is fixed.

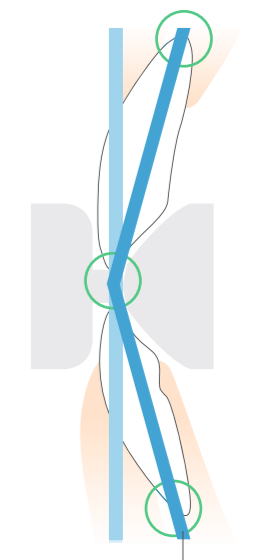

Adjusted Image Layer
Three point adjustment – the image layer position of the apical region at the mandibular, maxilla, and occlusal plane can be adjusted independently.

Cephalometric Imaging

High Speed

The Veraviewepocs system offers high speed performance requiring only 4.9 seconds for a cephalometric scan. The speed helps ensure high quality images each and every time. For pediatric patients, the reduced scan time is especially helpful as repeat images due to patient movement are virtually eliminated.

Low Dosage

With only a tenth of the dosage compared to a conventional X-ray*, the exposure level is significantly reduced.

High Quality Image with Wide Dynamic Range

You obtain far more information about hard and soft tissue – with just a single acquisition.

Variable Image Processing

The variable image processing technique generates optimum grayscale values by varying scanning speeds for hard and soft tissue. With this technique, the entire exposure time is only 4.1 seconds. Without this feature, the processing time is 4.9 seconds.

Processing Time

Imaging process can be completed within 20 seconds.

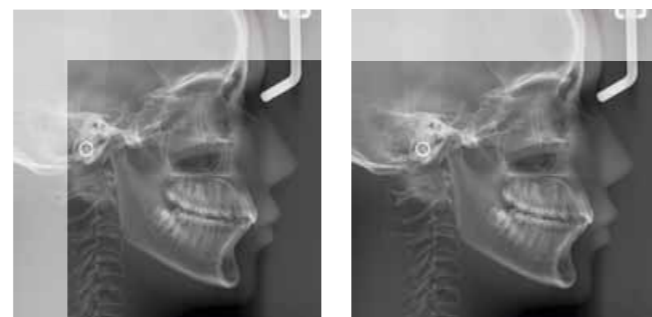

Partial Cephalometric Images

If not needed for examination, X-ray dosage can be reduced by eliminating the area behind the auditory canal. There are 3 partial image patterns.

Specifications

Trade name:	Veraviewepocs 3D
Model:	X550
Type:	Veraviewepocs 3D R100 Pan Veraviewepocs 3D R100 Pan/Ceph Veraviewepocs 3D F40 Pan Veraviewepocs 3D F40 Pan/Ceph
Input voltage:	EX-2: 220/230/240 V 50/60 Hz
Power consumption:	2.3 kVA
Dimensions	
Main unit:	W 1,020 x D 1,300 x H 2,355 mm
With Cephalometric:	W 2,000 x D 1,300 x H 2,355 mm
Weight:	Approx. 190 kg Approx. 260 kg with Cephalometric
X-ray generator	
Tube voltage:	60-90kV (depending on exposure mode)
Tube current:	1-10mA (depending on exposure mode)
Effective focal spot:	0.5 mm
3D image	
Exposure time:	Approx. 9.4 seconds
3D R100 imaging area:	Ø 40 mm x H 40 mm, Ø 40 mm x H 80 mm Ø 80 mm x H 50 mm, Ø 80 mm x H 80 mm
3D Reuleaux Full Arch FOV:	Ø 100 mm x H 50 mm, Ø 100 mm x H 80 mm
3D F40 Imaging area:	Ø 40 mm x H 40 mm, Ø 40 mm x H 80 mm

Panoramic image	
Exposure time:	Approx. 7.4 sec. for High Speed Mode (Standard Mode) Approx. 15 sec. for High Definition Mode (Standard Mode, 3D R100 only)
Imaging programs:	Standard Panoramic (standard, orthogonal and shadow reduction projections) Magnification: 1.3 X throughout and 1.6 X throughout
	Pedodontic Panoramic (standard, orthogonal and shadow reduction projections) Magnification: 1.3 X throughout and 1.6 X throughout
	Maxillary Sinus Panoramic (front and back) Magnification: 1.5 X throughout
	TMJ Quadruple Image Magnification: 1.3 X throughout
Cephalometric projections (option)	Posterior-anterior and Lateral

- Cephalometric is an optional feature.
- The Veraviewepocs 3D must be fixed to the floor and the wall.
- Always have patients wear X-ray protective equipment.

Machine Dimensions & Suggested Operating Space Requirements

Panoramic:

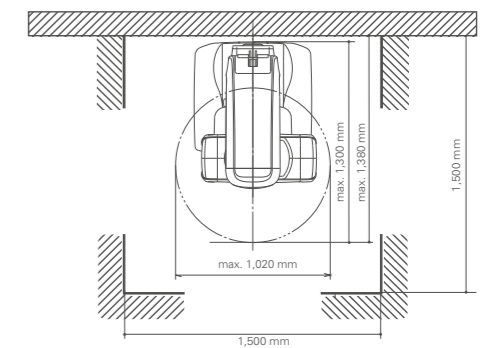
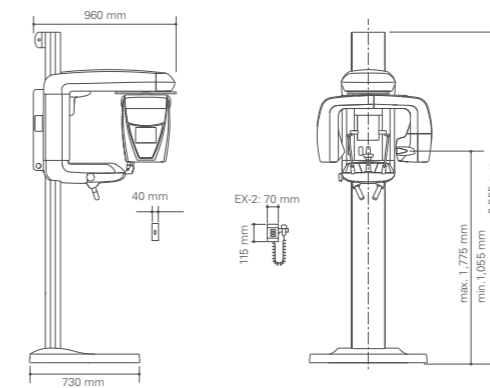

Panoramic/ Cephalometric:

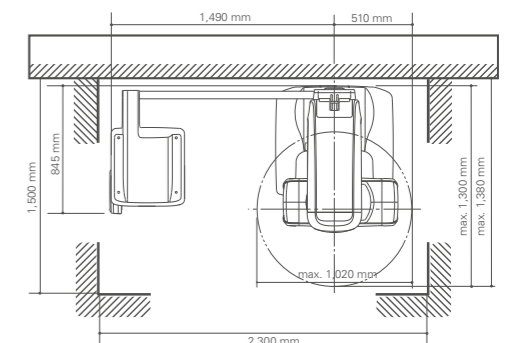
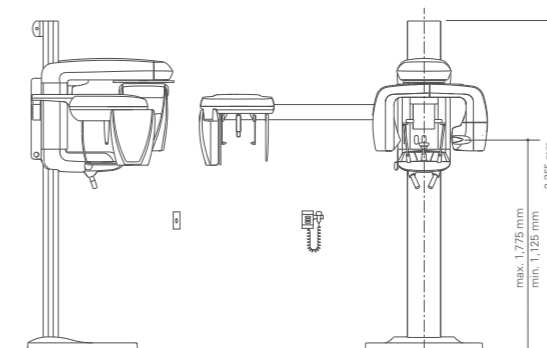

* Comparison made to Veraviewepocs film-based system

Diagnostic and Imaging Equipment

Treatment Units

Handpieces and Instruments

Endodontic Systems

Laser Equipment

Laboratory Devices



Developed and Manufactured by:

J. Morita Mfg. Corporation

680 Higashihama Minami-cho, Fushimi-ku, Kyoto, 612-8533 Japan
T +81 (0)75. 611 2141, F +81 (0)75. 622 4595
www.jmorita-mfg.com

Morita Global Website

www.morita.com

J. Morita Corporation

33-18, 3-Chome, Tarumi-cho Suita City, Osaka, 564-8650 Japan
T +81 (0)6. 6380 1521, F +81 (0)6. 6380 0585

J. Morita USA, Inc.

9 Mason Irvine, CA 92618, USA
T +1 (0)949. 581 9600, F +1 (0)949. 465 1095

J. Morita Europe GmbH

Justus-von-Liebig-Str. 27a, 63128 Dietzenbach, Germany
T +49 (0)6074. 836 0, F +49 (0)6074. 836 299
www.morita.com/europe

Siamdent Co., Ltd.

444 Olympia Thai Tower, 3rd Floor, Ratchadapisek Road, Samsennok,
Huay Kwang, Bangkok 10310, Thailand
T +66 (0)2. 512 6049, F +66 (0)2. 512 6099, www.siamdent.com

J. Morita Corporation Australia & New Zealand

Suite 2.05, 247 Coward Street, Mascot, NSW 2020, Australia
T +61 (0)2. 9667 3555, F +61 (0)2. 9667 3577

J. Morita Middle East

4 Tag Al Aoasaa, Saba Pacha 21311, Alexandria, Egypt
T +203 (0)58. 222 94, F +203 (0)58. 222 96